

ARCHITECTURAL DRAFTING & DESIGN

Architectural Woodworking



Cabinetry & Furniture



Stairs



Floor Plans

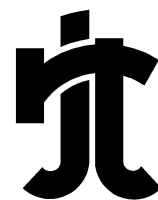

RJT DESIGNS

PO Box 541

Waterford, CT 06385

P: 860.514.0146 F: 203.286.2171

E: cadservice@rjtdesigns.com W: www.rjtdesigns.com



This document is the property of RJT DESIGNS.
No part of this work may be reproduced in any manner whatsoever
without the prior written permission from RJT DESIGNS.

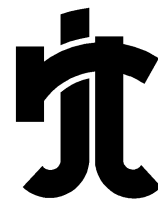

RJT DESIGNS

PO Box 541

Waterford, CT 06385

P: 860.514.0146 F: 203.286.2171

E: cadservice@rjtdesigns.com W: www.rjtdesigns.com

BATHS



RJT DESIGNS

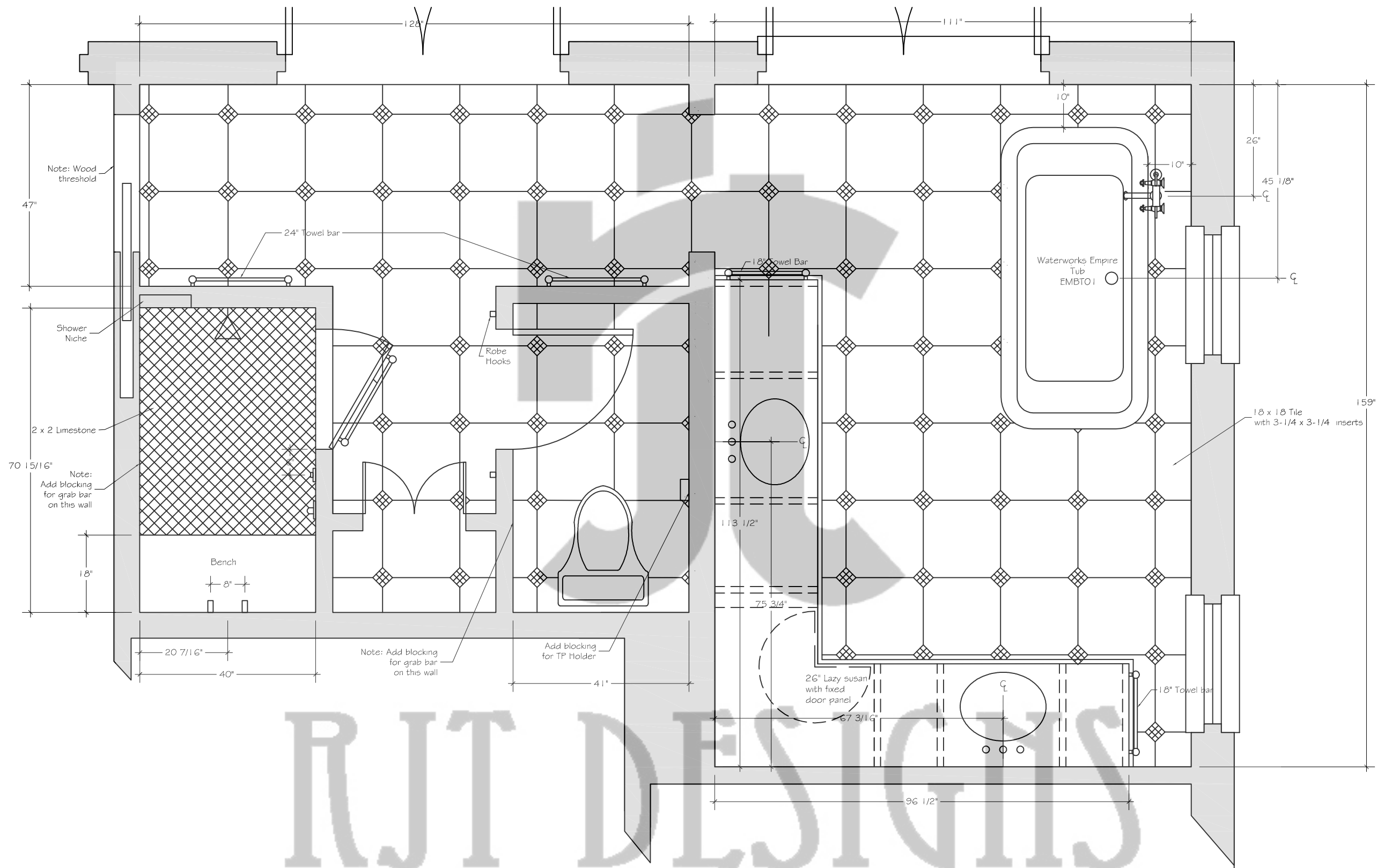

RJT DESIGNS

MASTER BATH PLAN
SCALE: 1/2" = 1'-0"

COPYRIGHT © 2010 RJT DESIGNS



rjt designs

Architectural Drafting & Design

Master Bath
Version 2

Date: 4/09/07
Revised: 7/23/08

Mba-1
8

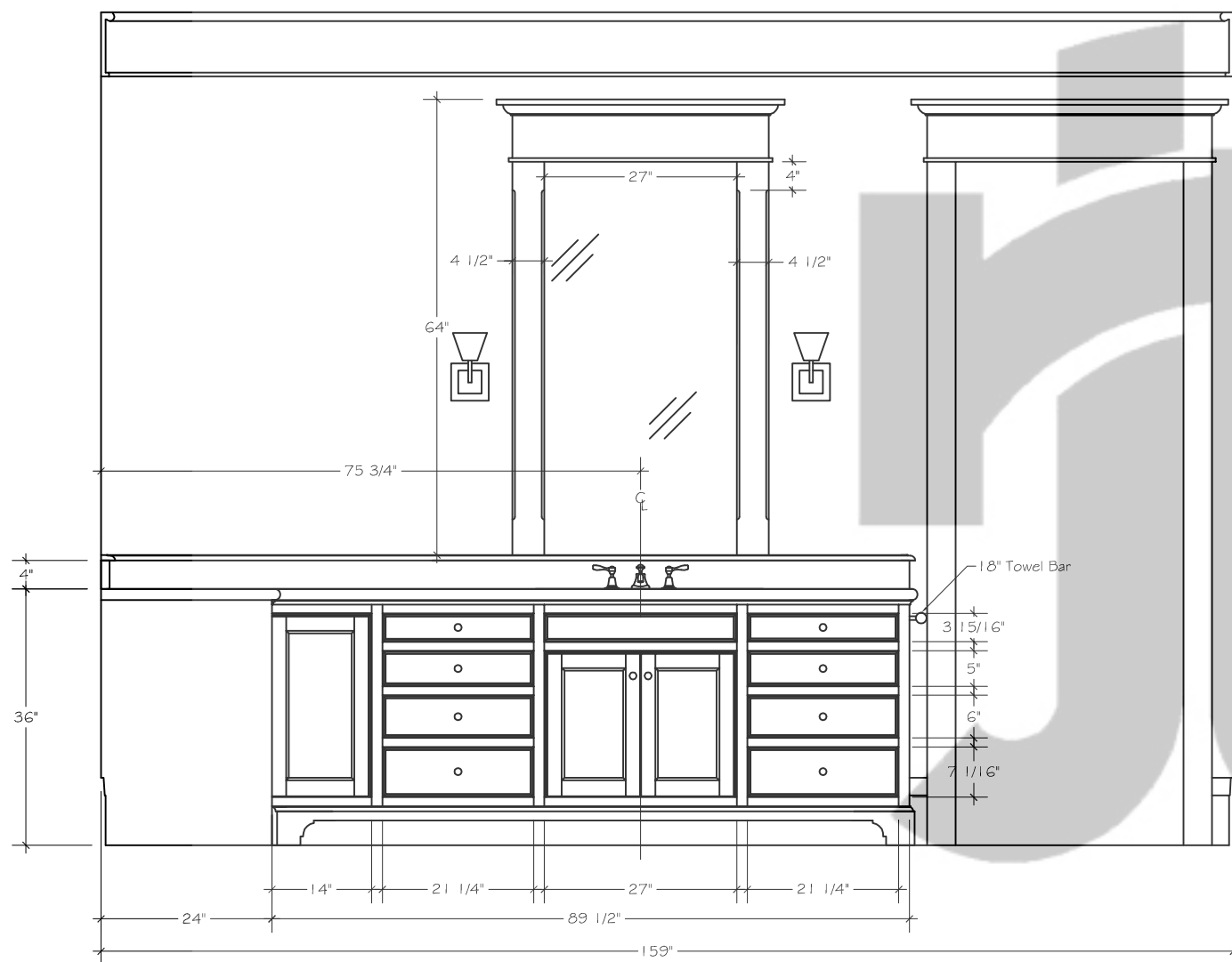

1 MASTER BATH ELEVATION
SCALE: 1/2" = 1'-0"

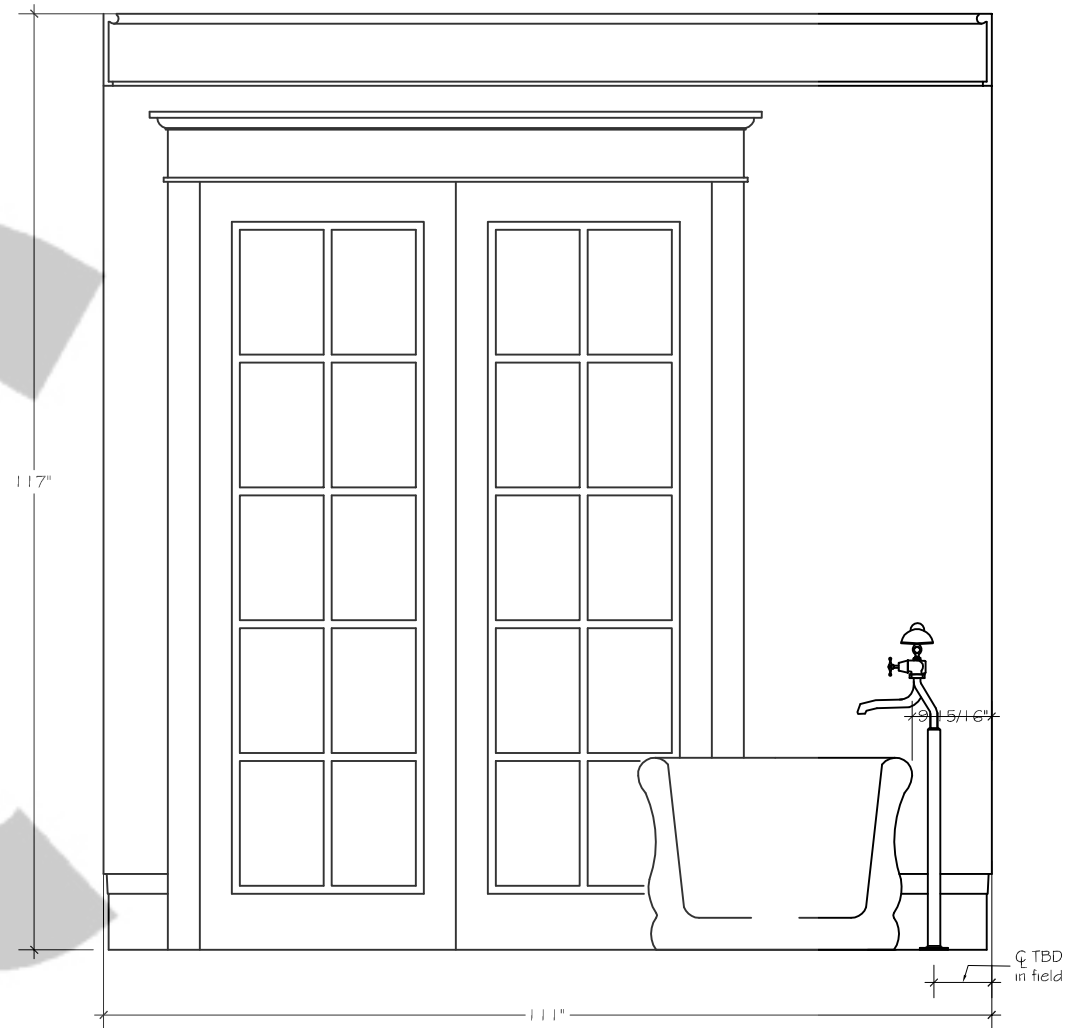

2 MASTER BATH ELEVATION
SCALE: 1/2" = 1'-0"

RJT DESIGNS

COPYRIGHT © 2010 RJT DESIGNS



rjt designs

Architectural Drafting & Design

Master Bath

Date: 4/09/07
Revised: 1/07/08

Mba-2 6

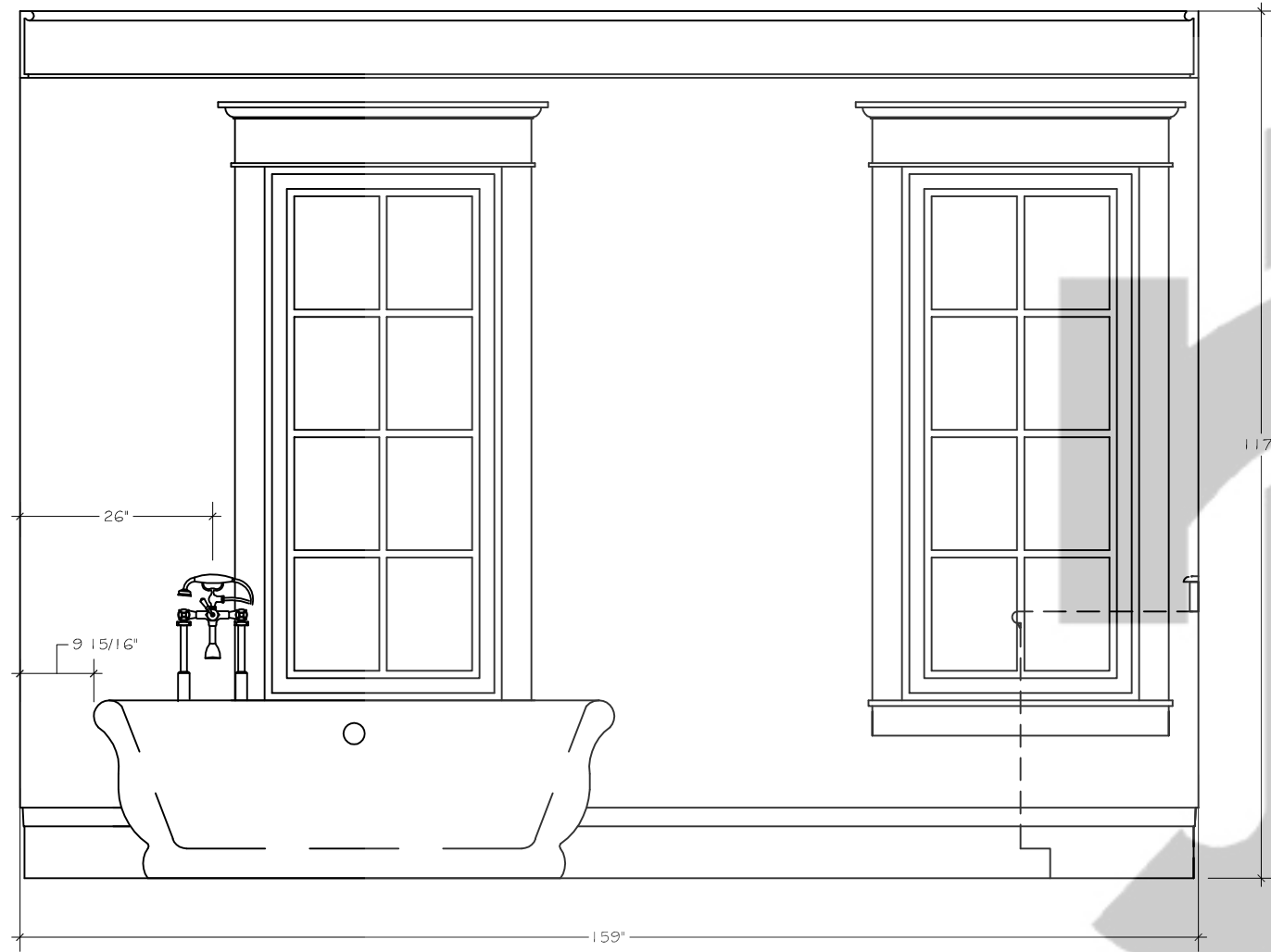

3 MASTER BATH ELEVATION
SCALE: 1/2" = 1'-0"

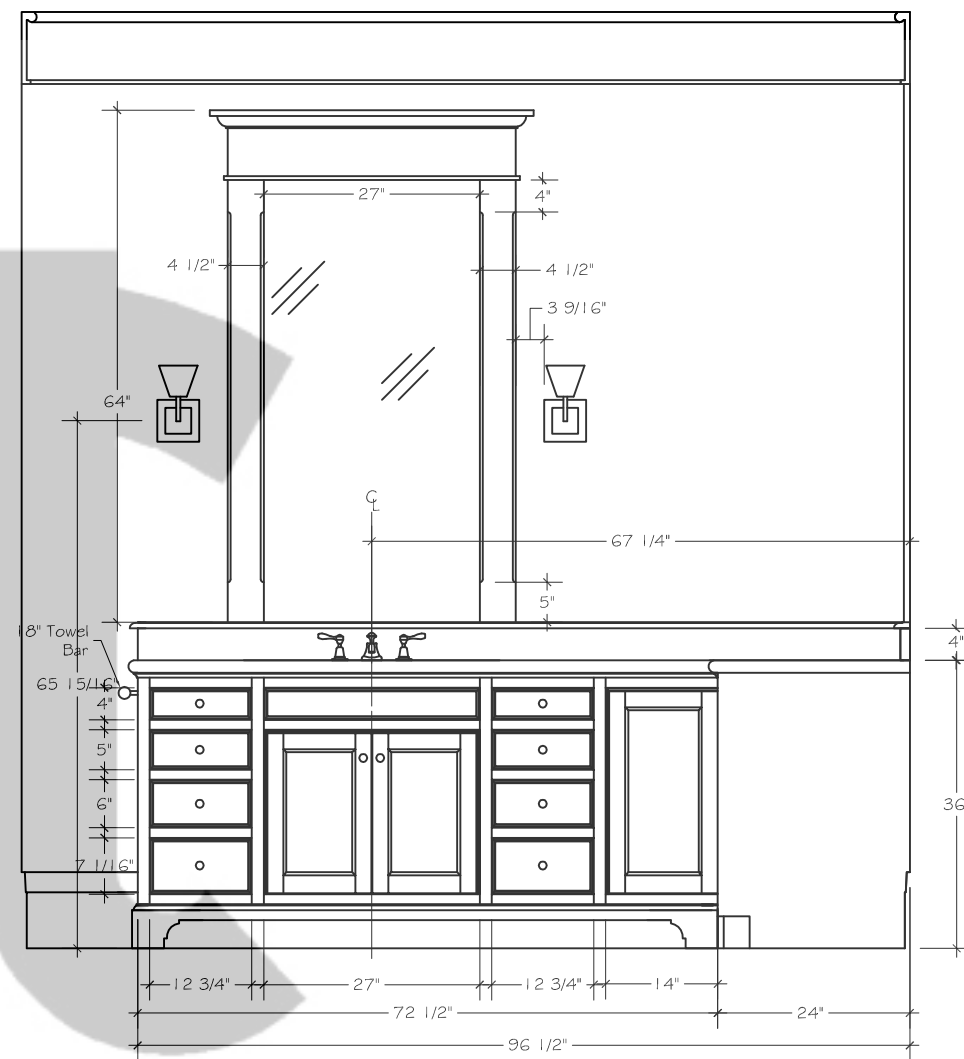

4 MASTER BATH ELEVATION
SCALE: 1/2" = 1'-0"

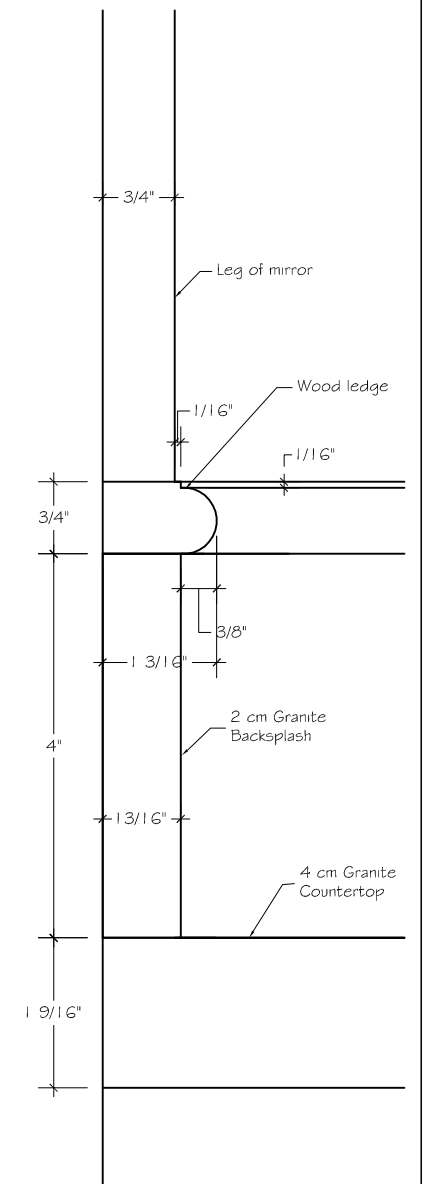

5 MASTER BATH DETAIL
SCALE: HALF

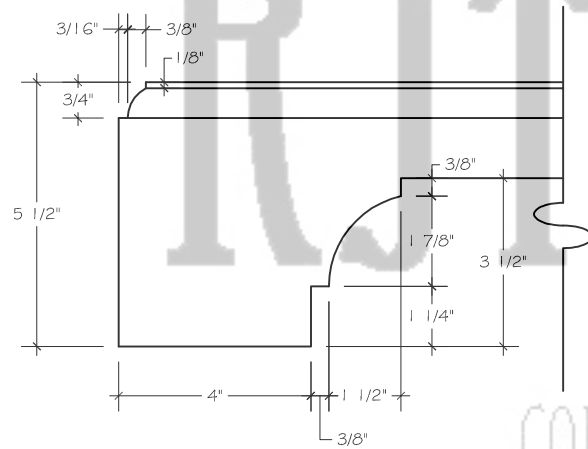

6 TYPICAL BASE DETAIL
SCALE: 3" = 1'-0"

RJT DESIGNS

COPYRIGHT © 2010 RJT DESIGNS



rjt designs

Architectural Drafting & Design

Master Bath

Date: 4/09/07
Revised: 1/07/08

Mba-3 Rev. 6

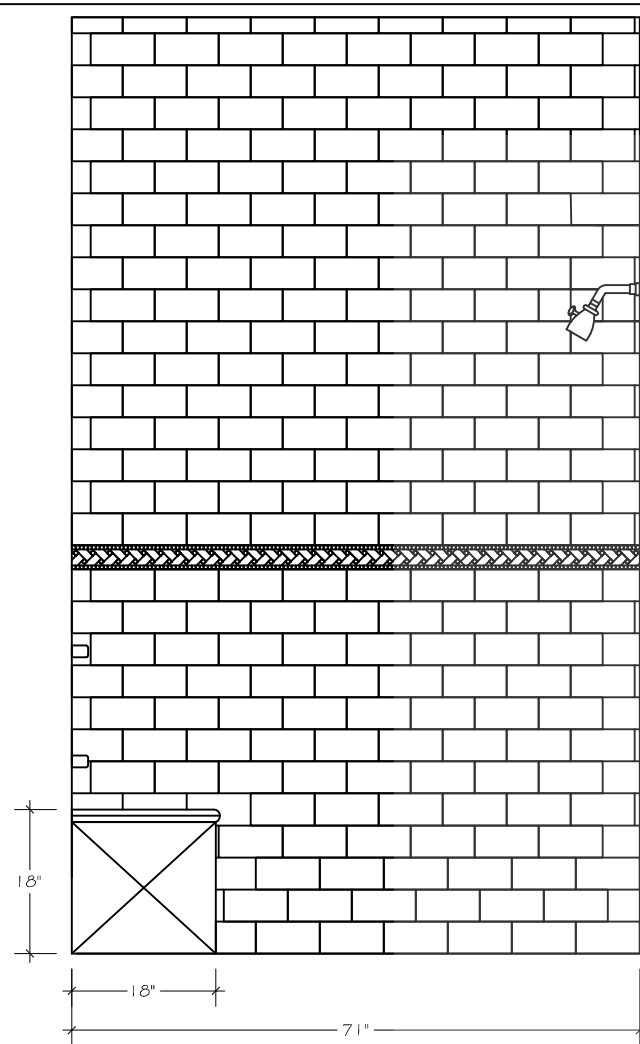

1 MASTER BATH SHOWER
SCALE: 1/2" = 1'-0"

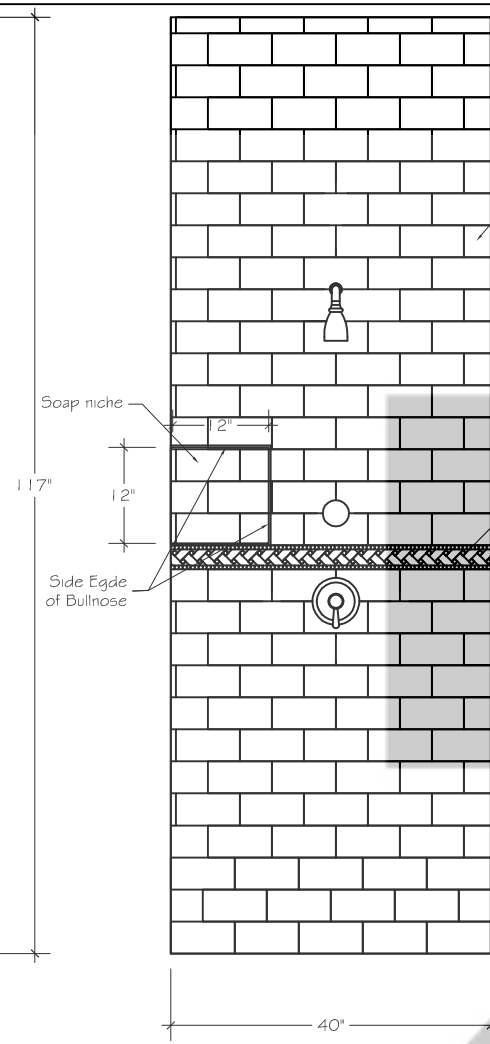

2 MASTER BATH SHOWER
SCALE: 1/2" = 1'-0"

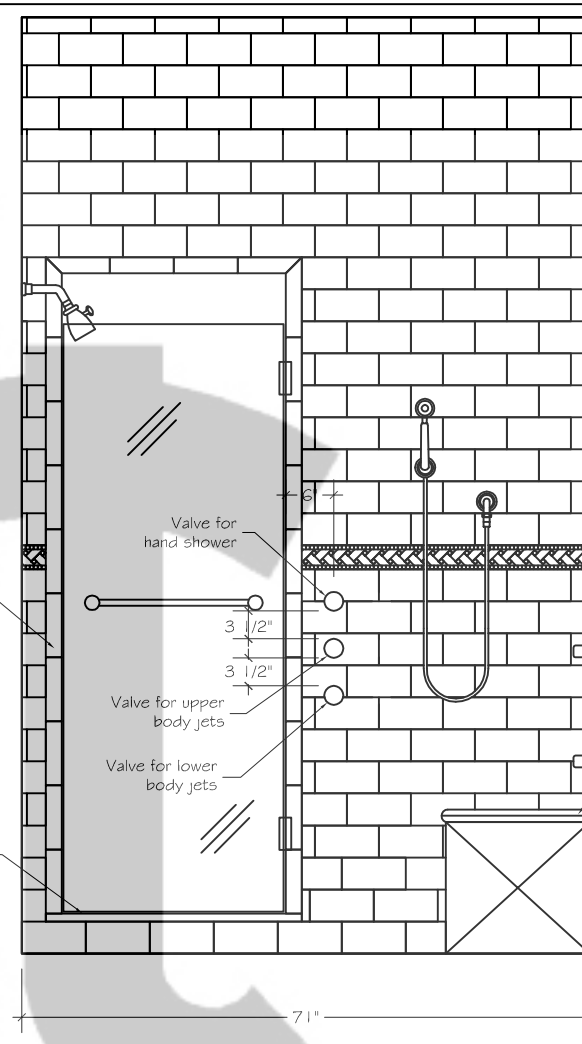

3 MASTER BATH SHOWER
SCALE: 1/2" = 1'-0"

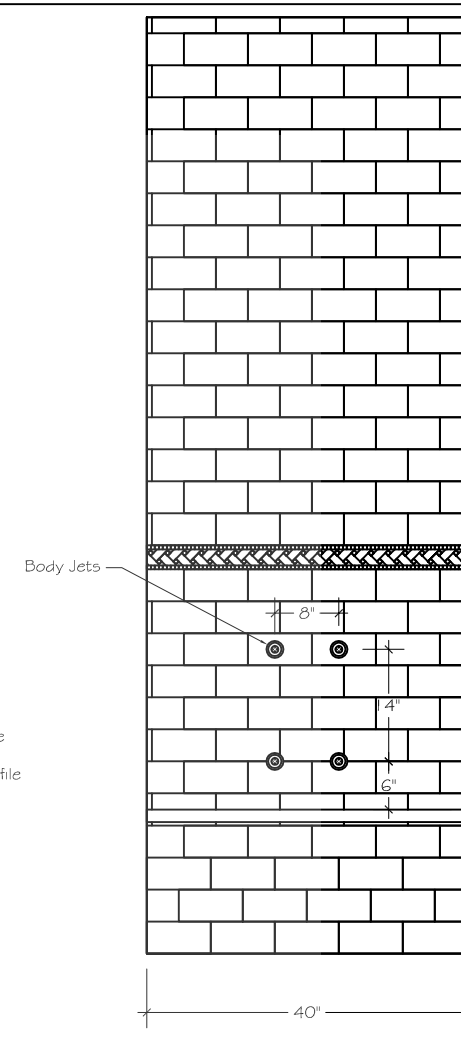

4 MASTER BATH SHOWER
SCALE: 1/2" = 1'-0"

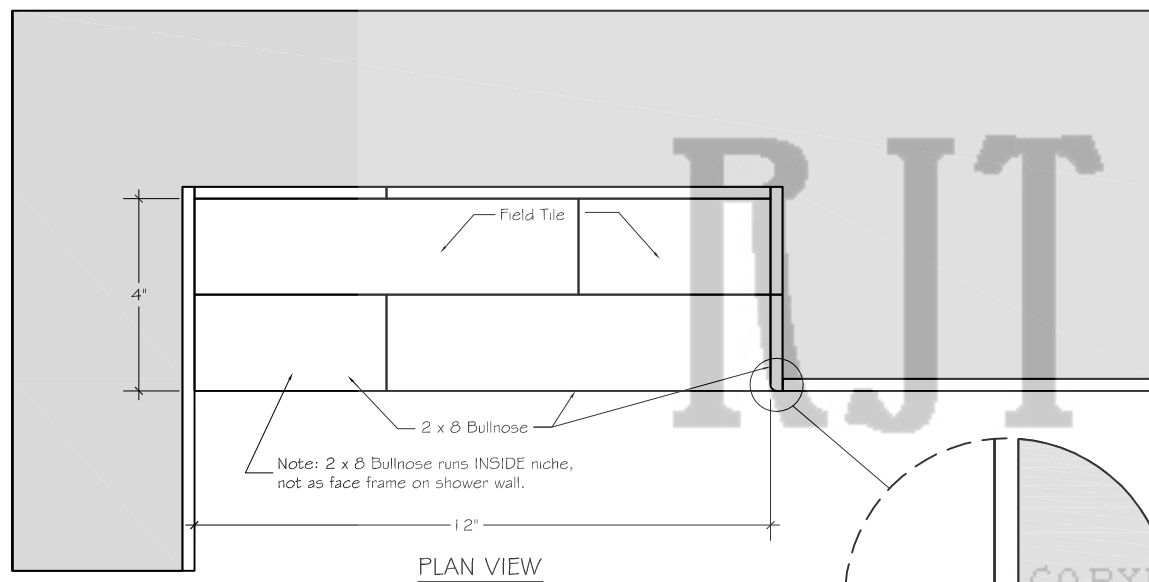

6 SHOWER NICHE DETAIL
SCALE: 3" = 1'-0"

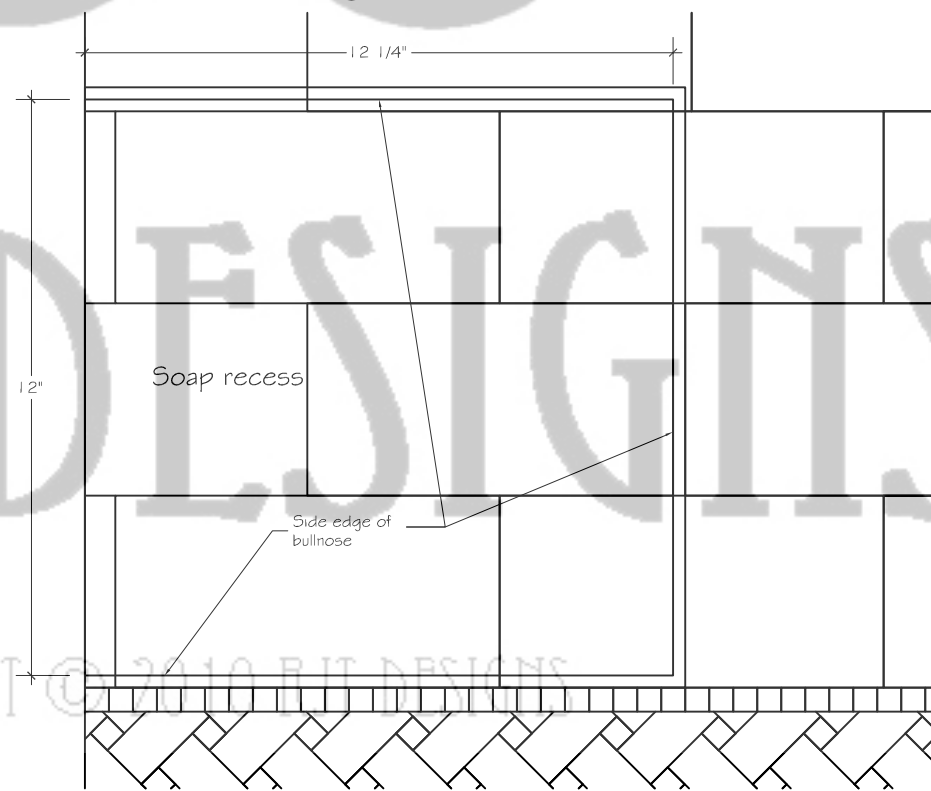

7 SHOWER NICHE DETAIL
SCALE: 3" = 1'-0"

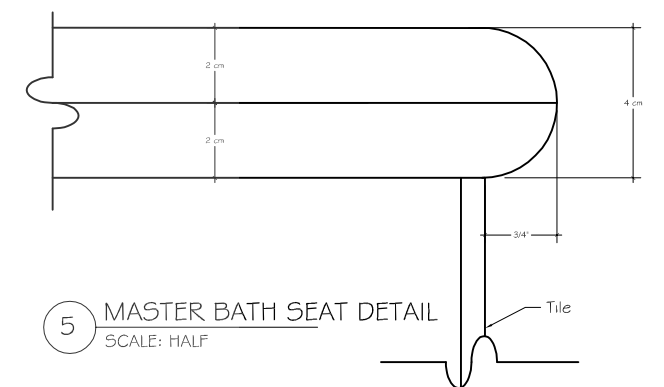

5 MASTER BATH SEAT DETAIL
SCALE: HALF



rjt designs

Architectural Drafting & Design

Master Bath

Date: 4/09/07
Revised: 1/07/08

Rev. Mba-4 6

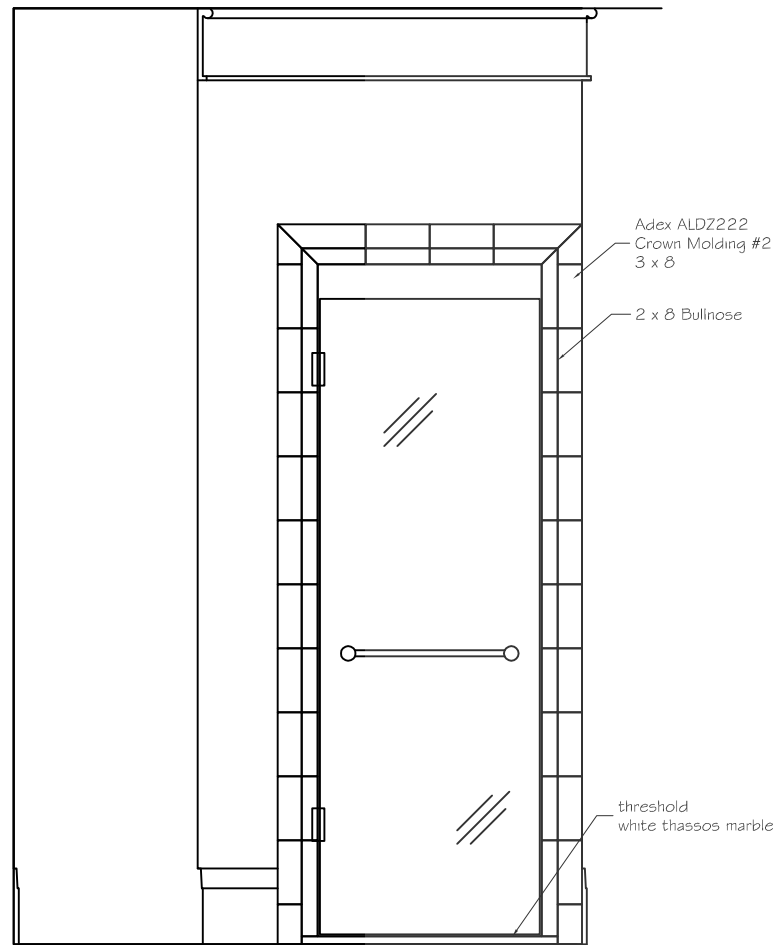

1 MASTER BATH SHOWER
SCALE: 1/2" = 1'-0"

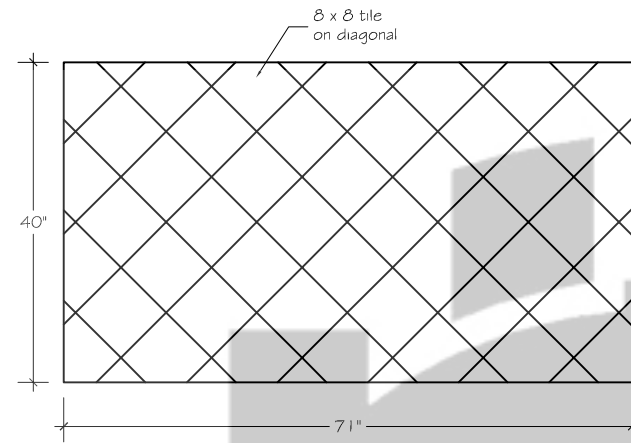

2 MASTER BATH SHOWER - CEILING
SCALE: 1/2" = 1'-0"

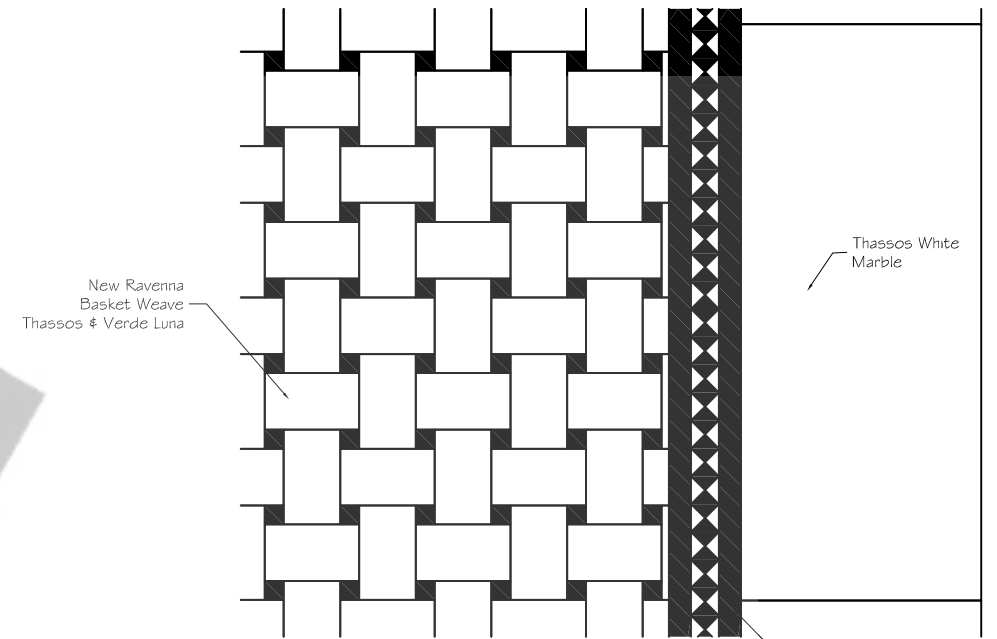

4 TILE DETAIL
SCALE: 3" = 1'-0"

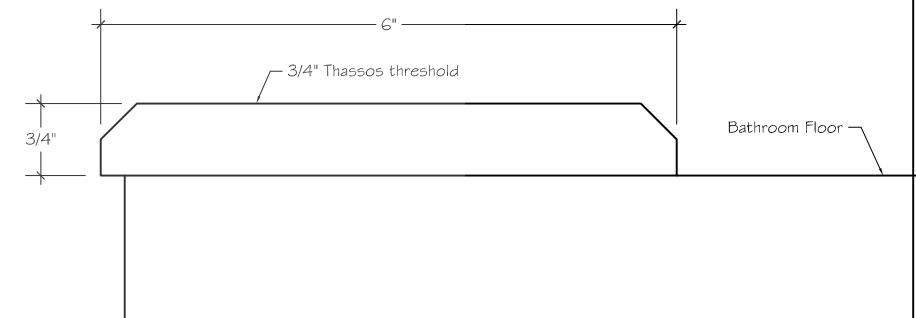

3 MASTER BATH SHOWER - THRESHOLD
SCALE: HALF

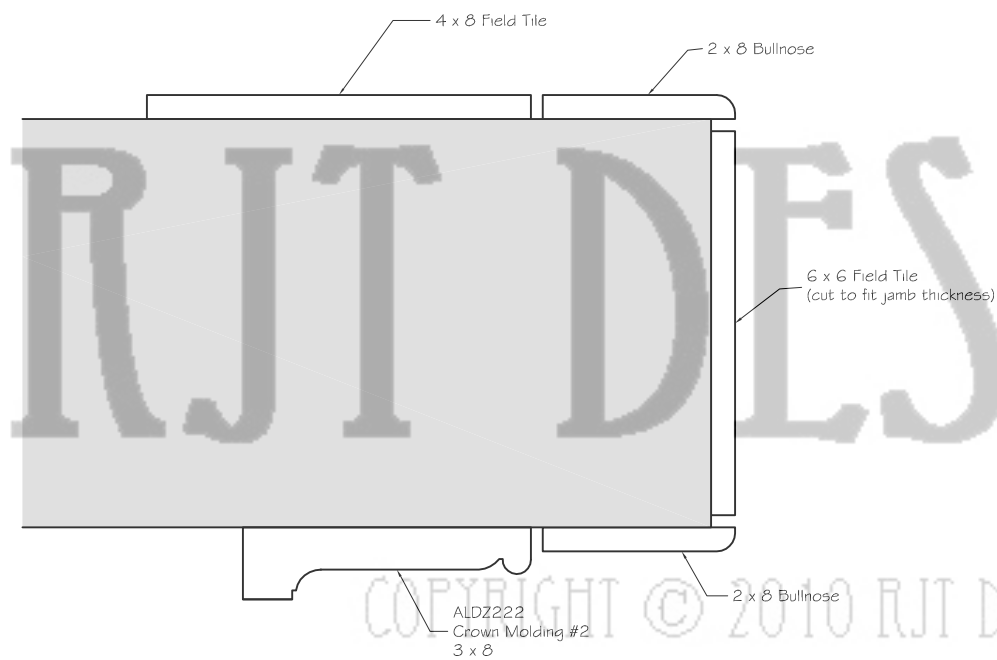

5 MASTER BATH SHOWER - JAMB
SCALE: HALF



rjt designs

Architectural Drafting & Design

Master Bath

Date: 4/09/07
Revised: 1/07/08

Mba-5 6